

Mike Mansfield (B301384)
Ogden, UT



Report

2014 Buick Lacrosse Leather

168,352 mi | VIN: 1G4GB5G36EF191039 |

Sedan 4 DR | 3.6L V6 F DOHC 24V | Gasoline | Front wheel drive



ACCIDENT

Accident Reported

GOOD RELIABILITY



53 Service history records

4 Previous owners

Types of owners: Personal lease, Personal

Last owned in Utah

96 Detailed records available

This CARFAX Vehicle History Report is based only on information supplied to CARFAX and available as of 4/8/26 at 5:52:29 PM (CDT). Other information about this vehicle, including problems, may not have been reported to CARFAX. Use this report as one important tool, along with a vehicle inspection and test drive, to make a better decision about your next used car.



Accident / Damage History

Not all accidents / issues are reported to CARFAX

Event 1

10/17/2014

Accident reported

- Vehicle involved in a rear-end collision with another motor vehicle

Event 2

11/10/2014

Accident reported: minor damage

- Vehicle involved in a rear-end collision with another motor vehicle
- Airbags did not deploy

Damage Severity Scale

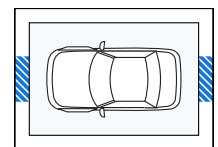
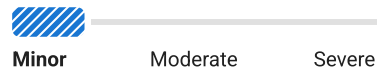

Event 3

06/01/2015

Accident reported

- Vehicle involved in a sideswipe collision with another motor vehicle

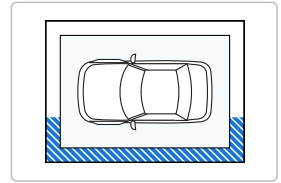

Event 4

04/08/2017

Accident reported: minor damage

- Vehicle involved in a rear-end collision with another motor vehicle

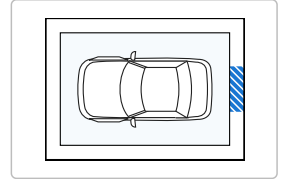
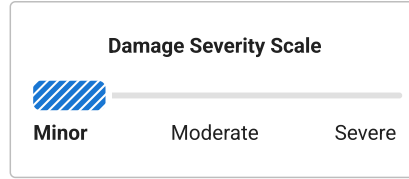

Event 5

04/22/2017

Accident reported

- Vehicle involved in a sideswipe collision with another motor vehicle
- Airbags did not deploy

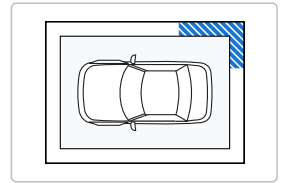

Event 6

02/07/2022

Damage reported: minor damage

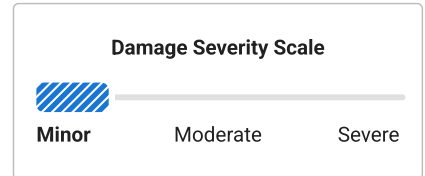

CARFAX Recent Service Highlights

Key services performed in the last 12 months

Service	Comments	Date
Oil	✓ Oil and filter changed	06/25/2025
Tires	✓ Alignment performed ✓ Four wheel alignment performed	09/26/2025

This car has been recently serviced. That's a good thing!

CARFAX Reliability Forecast

Based on 2014 Buick Lacrosse Leather with similar mileage

3-Year Reliability Forecast

What makes this vehicle have **good reliability**?

Fair Reliability

Good Reliability

Great Reliability

Good news! This vehicle is expected to have average risk of repair and average repair costs.



\$\$\$ **Average Repair Cost**
\$380 avg per year

🔧 **Average Likelihood of Repair**

CARFAX Additional History Not all accidents / issues are reported to CARFAX	👤 Owners 1-2	👤 Owner 3	👤 Owner 4
Total Loss No total loss reported to CARFAX.	✅ No Issues Reported	✅ No Issues Reported	✅ No Issues Reported
Structural Damage CARFAX recommends that you have this vehicle inspected by a collision repair specialist.	✅ No Issues Reported	✅ No Issues Reported	✅ No Issues Reported
Airbag Deployment No airbag deployment reported to CARFAX.	✅ No Issues Reported	✅ No Issues Reported	✅ No Issues Reported
Odometer Check No indication of an odometer rollback.	✅ No Issues Indicated	✅ No Issues Indicated	✅ No Issues Indicated
Accident / Damage Accidents reported: 10/17/2014, 11/10/2014, 06/01/2015, 04/08/2017, and 04/22/2017. Damage reported: 02/07/2022.	Accident Reported	Damage Reported	No New Issues Reported
Manufacturer Recall No open recalls reported to CARFAX. Check for open recalls on GM vehicles at recalls.gm.com.	✅ No Recalls Reported	✅ No Recalls Reported	✅ No Recalls Reported
Basic Warranty Original warranty estimated to have expired.	Warranty Expired	Warranty Expired	Warranty Expired

CARFAX Title History CARFAX guarantees the information in this section	👤 Owners 1-2	👤 Owner 3	👤 Owner 4
Damage Brands Salvage Junk Rebuilt Fire Flood Hail Lemon	✅ Guaranteed No Problem	✅ Guaranteed No Problem	✅ Guaranteed No Problem
Odometer Brands Not Actual Mileage Exceeds Mechanical Limits	✅ Guaranteed No Problem	✅ Guaranteed No Problem	✅ Guaranteed No Problem



GUARANTEED - None of these title problems were reported by a U.S. state Department of Motor Vehicles (DMV). If you find that any of these title problems were reported by a DMV and not included in this report, you may qualify.
[View Terms](#) | [View Certificate](#)

CARFAX Ownership History The number of owners is estimated	👤 Owners 1-2	👤 Owner 3	👤 Owner 4
Year purchased	2014	2018	2022
Type of owner	See Details	Personal	Personal
Estimated length of ownership	4 yrs. 5 mo.	4 years	3 yrs. 6 mo.
Owned in the following states/provinces	See Details	Washington, Utah	Utah
Estimated miles driven per year	See Details	17,497/yr	12,932/yr
Last reported odometer reading	53,891	124,221	168,352





CARFAX Detailed History

 **Owner 1**
Purchased: 2014



Low mileage! This owner drove less than the industry average of 15,000 miles per year.

Personal Lease Vehicle
13,700 mi/yr

Date	Mileage	Source		Comments
12/16/2013	1	Rogers Auto Group Chicago, IL 312-225-4300 ★ 4.4 / 5.0 143 Verified Reviews		Vehicle offered for sale
02/01/2014	13	Rogers Auto Group Chicago, IL 312-225-4300 ★ 4.4 / 5.0 143 Verified Reviews		Vehicle sold
02/01/2014		Illinois Motor Vehicle Dept.		Vehicle purchase reported
02/18/2014		Napleton Downtown Chevrolet Buick GMC Hyundai Chicago, IL 312-225-4300 ★ 4.3 / 5.0 604 Verified Reviews ❤️ 1,961 Customer Favorites		Vehicle serviced - Pre-delivery inspection completed - Wheel locks installed
02/26/2014		Illinois Motor Vehicle Dept. Chicago, IL Title #140576990370		Title issued or updated - Registration issued or renewed - First owner reported - Titled or registered as personal lease vehicle - Loan or lien reported - Vehicle color noted as Black
05/08/2014	5,428	Napleton Downtown Chevrolet Buick GMC Hyundai Chicago, IL 312-225-4300 ★ 4.3 / 5.0 604 Verified Reviews ❤️ 1,961 Customer Favorites		Vehicle serviced - Maintenance inspection completed
08/06/2014	10,360	Napleton Downtown Chevrolet Buick GMC Hyundai Chicago, IL 312-225-4300 ★ 4.3 / 5.0 604 Verified Reviews ❤️ 1,961 Customer Favorites		Vehicle serviced
10/17/2014		Damage Report		Accident reported - Vehicle involved in a rear-end collision with another motor vehicle
10/31/2014	17,077	Mike Haggerty Buick GMC, Inc. Oak Lawn, IL 708-423-5000 ★ 4.3 / 5.0 884 Verified Reviews ❤️ 6,675 Customer Favorites		Vehicle serviced - Maintenance inspection completed - Front driveshaft replaced
11/10/2014		Damage Report		Accident reported: minor damage - Vehicle involved in a rear-end collision with another motor vehicle - Damage to rear - Damage to front - Airbags did not deploy

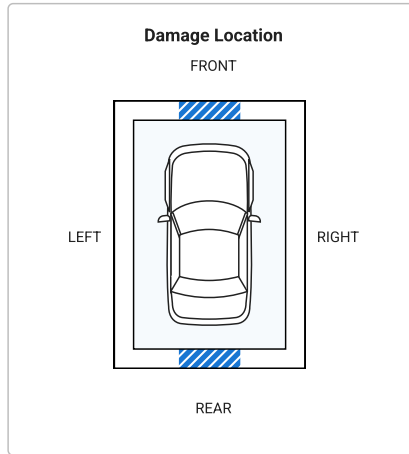
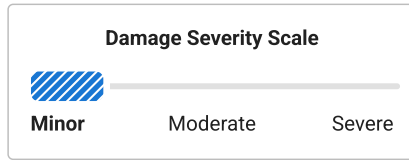

11/20/2014	19,006	<p>Mike Haggerty Buick GMC, Inc. Oak Lawn, IL 708-423-5000</p> <p>★ 4.3 / 5.0 884 Verified Reviews</p> <p>♥ 6,675 Customer Favorites</p>	<p>Vehicle serviced - Alignment performed - Lower control arm(s) replaced</p>
12/22/2014	19,483	<p>Mike Haggerty Buick GMC, Inc. Oak Lawn, IL 708-423-5000</p> <p>★ 4.3 / 5.0 884 Verified Reviews</p> <p>♥ 6,675 Customer Favorites</p>	<p>Vehicle serviced</p>
01/12/2015	21,079	<p>Napleton Downtown Chevrolet Buick GMC Hyundai Chicago, IL 312-225-4300</p> <p>★ 4.3 / 5.0 604 Verified Reviews</p> <p>♥ 1,961 Customer Favorites</p>	<p>Vehicle serviced - Battery replaced</p>
02/10/2015	21,892	<p>Napleton Downtown Chevrolet Buick GMC Hyundai Chicago, IL 312-225-4300</p> <p>★ 4.3 / 5.0 604 Verified Reviews</p> <p>♥ 1,961 Customer Favorites</p>	<p>Vehicle serviced - Maintenance inspection completed - Tire condition and pressure checked</p>
03/01/2015		<p>Illinois Motor Vehicle Dept. Chicago, IL</p>	<p>Registration issued or renewed</p>
03/16/2015	24,013	<p>Napleton Downtown Chevrolet Buick GMC Hyundai Chicago, IL 312-225-4300</p> <p>★ 4.3 / 5.0 604 Verified Reviews</p> <p>♥ 1,961 Customer Favorites</p>	<p>Vehicle serviced - Maintenance inspection completed - Oil and filter changed</p>
06/01/2015		<p>Damage Report</p>	<p>Accident reported - Vehicle involved in a sideswipe collision with another motor vehicle - Damage to left front - Damage to left rear - Damage to left side</p>

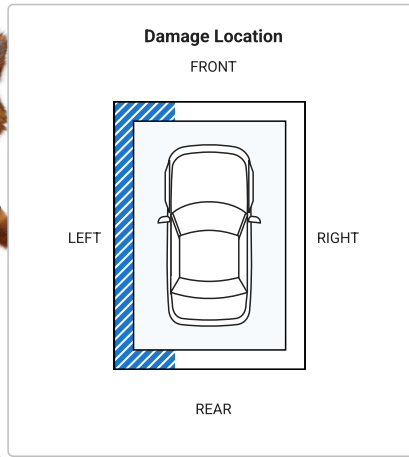

07/28/2015	29,293	<p>Mike Haggerty Buick GMC, Inc. Oak Lawn, IL 708-423-5000</p> <p>★ 4.3 / 5.0 884 Verified Reviews ♥ 6,675 Customer Favorites</p>		<p>Vehicle serviced - Maintenance inspection completed</p>
08/04/2015	29,418	<p>Napleton Downtown Chevrolet Buick GMC Hyundai Chicago, IL 312-225-4300</p> <p>★ 4.3 / 5.0 604 Verified Reviews ♥ 1,961 Customer Favorites</p>		<p>Vehicle serviced - Maintenance inspection completed - Recommended maintenance performed</p>
12/15/2015	33,514	<p>Napleton Downtown Chevrolet Buick GMC Hyundai Chicago, IL 312-225-4300</p> <p>★ 4.3 / 5.0 604 Verified Reviews ♥ 1,961 Customer Favorites</p>		<p>Vehicle serviced - Maintenance inspection completed - 7,500 mile service performed</p>
02/26/2016		<p>Illinois Motor Vehicle Dept. Chicago, IL</p>		<p>Registration issued or renewed</p>
05/05/2016	37,015	<p>Napleton Downtown Chevrolet Buick GMC Hyundai Chicago, IL 312-225-4300</p> <p>★ 4.3 / 5.0 604 Verified Reviews ♥ 1,961 Customer Favorites</p>		<p>Vehicle serviced - Maintenance inspection completed - 7,500 mile service performed - Air filter replaced - Cabin air filter replaced/cleaned</p>
11/02/2016	42,456	<p>Napleton Downtown Chevrolet Buick GMC Hyundai Chicago, IL 312-225-4300</p> <p>★ 4.3 / 5.0 604 Verified Reviews ♥ 1,961 Customer Favorites</p>		<p>Vehicle serviced - Maintenance inspection completed - 7,500 mile service performed</p>
03/31/2017		<p>Illinois Motor Vehicle Dept. Chicago, IL</p>		<p>Registration issued or renewed - Correction to record</p>
04/08/2017		<p>Damage Report</p>		<p>Accident reported: minor damage - Vehicle involved in a rear-end collision with another motor vehicle - Damage to rear</p>



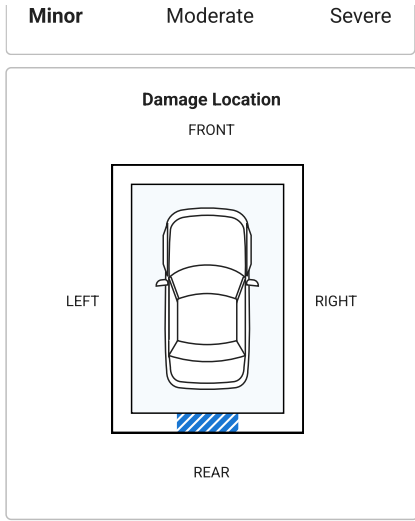

04/21/2017

45,943

Napleton Downtown Chevrolet
Buick GMC Hyundai
Chicago, IL
312-225-4300



Vehicle serviced

★ **4.3 / 5.0** 604 Verified Reviews

♥ **1,961** Customer Favorites

04/22/2017

Damage Report



Accident reported

- Vehicle involved in a sideswipe collision with another motor vehicle
- Damage to right rear
- Airbags did not deploy

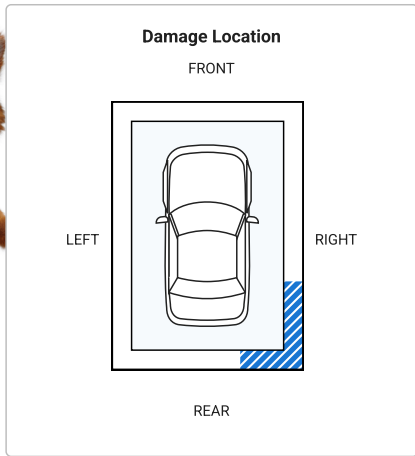

06/22/2017

46,430

Auto Auction

Vehicle sold



Millions of used vehicles are bought and sold at auction every year.

07/05/2017

Wyatt-Johnson Hyundai Subaru
Mazda
Clarksville, TN
931-648-4300

Vehicle offered for sale

★ **4.5 / 5.0** 94 Verified Reviews

08/21/2017

46,442

Wyatt-Johnson Hyundai Subaru
Mazda
Clarksville, TN
931-648-1098



Vehicle serviced







- Computer(s) checked
- Vehicle washed/detailed

★ **4.5 / 5.0** 289 Verified Reviews



♥ **24** Customer Favorites

09/01/2017	46,609	Wyatt-Johnson Hyundai Subaru Mazda Clarksville, TN 931-648-4300 ★ 4.5 / 5.0 94 Verified Reviews	Vehicle sold
09/01/2017		Tennessee Motor Vehicle Dept.	Vehicle purchase reported
09/06/2017	46,684	Wyatt-Johnson Hyundai Subaru Mazda Clarksville, TN 931-648-1098 ★ 4.5 / 5.0 289 Verified Reviews ❤️ 24 Customer Favorites	 Vehicle serviced - Body electrical system checked - Brakes checked - One tire replaced - Steering/suspension checked

 **Owner 2** Personal Vehicle
Purchased: 2017





Date	Mileage	Source	Comments
09/12/2017		Tennessee Motor Vehicle Dept. Clarksville, TN Title #09076619	Title or registration issued - New owner reported - Loan or lien reported
09/15/2017	46,867	Wyatt-Johnson GMC Clarksville, TN 931-647-5651 ★ 4.7 / 5.0 464 Verified Reviews ❤️ 1,349 Customer Favorites	 Vehicle serviced - Maintenance inspection completed - Sensing and diagnostic module reprogrammed
10/31/2017	47,603	Wyatt-Johnson Hyundai Subaru Mazda Clarksville, TN 931-648-1098 ★ 4.5 / 5.0 289 Verified Reviews ❤️ 24 Customer Favorites	 Vehicle serviced - Computer(s) checked
11/28/2017	47,993	Wyatt-Johnson GMC Clarksville, TN 931-647-5651 ★ 4.7 / 5.0 464 Verified Reviews ❤️ 1,349 Customer Favorites	 Vehicle serviced - Maintenance inspection completed - A/C system checked - Body electrical system checked - Radio replaced - Steering/suspension checked - Timing chain replaced
12/12/2017	48,483	Wyatt-Johnson GMC Clarksville, TN 931-647-5651 ★ 4.7 / 5.0 464 Verified Reviews ❤️ 1,349 Customer Favorites	 Vehicle serviced - Maintenance inspection completed - Body electrical system checked - Engine checked - Transmission checked
02/14/2018	49,022	Wyatt-Johnson GMC Clarksville, TN 931-647-5651 ★ 4.7 / 5.0 464 Verified Reviews ❤️ 1,349 Customer Favorites	 Vehicle serviced - Maintenance inspection completed - Steering/suspension checked
02/26/2018	49,352	Weeks Chevrolet GMC West Frankfort, IL 618-937-8488 ★ 4.6 / 5.0 41 Verified Reviews ❤️ 42 Customer Favorites	 Vehicle serviced - Camshaft position sensor replaced
04/03/2018		Washington Motor Vehicle Dept. Vancouver, WA	Title issued or updated - Loan or lien reported - Registration updated when owner moved the vehicle to a new location

- Vehicle color noted as Black

05/11/2018	52,016	Meineke Car Care Center Vancouver, WA 360-258-1743 ★ 4.5 / 5.0 67 Verified Reviews ♥ 800 Customer Favorites		Vehicle serviced - Maintenance inspection completed - A/C system checked - A/C refrigerant recharged - Brakes checked
07/07/2018	53,891	Dealer Inventory		Vehicle offered for sale
08/28/2018		Alan Webb Mazda Vancouver, WA 360-574-1131 ★ 4.6 / 5.0 443 Verified Reviews ♥ 5,231 Customer Favorites		Vehicle serviced - Battery replaced - Oil and filter changed - Vehicle washed/detailed

 **Owner 3**
Purchased: 2018

Personal Vehicle
17,497 mi/yr

Date	Mileage	Source		Comments
09/06/2018		Washington Motor Vehicle Dept. Battle Ground, WA Title #1755951597		Title issued or updated - New owner reported - Loan or lien reported - Vehicle color noted as Black
09/13/2018	54,807	Alan Webb Mazda Vancouver, WA 360-574-1131 ★ 4.6 / 5.0 443 Verified Reviews ♥ 5,231 Customer Favorites		Vehicle serviced
12/06/2018	58,703	Alan Webb Chevrolet Vancouver, WA 360-450-0021 ★ 4.5 / 5.0 320 Verified Reviews ♥ 13 Customer Favorites		Vehicle serviced - Transmission fluid changed - Transmission fluid flushed
08/16/2019		Washington Motor Vehicle Dept. Battle Ground, WA Title #1755951597		Registration issued or renewed - Loan or lien reported - Vehicle color noted as Black
12/06/2019	74,065	Alan Webb Chevrolet Vancouver, WA 360-450-0021 ★ 4.5 / 5.0 320 Verified Reviews ♥ 13 Customer Favorites		Vehicle serviced - Maintenance inspection completed - Oil and filter changed - Tires rotated
06/29/2020	78,871	Alan Webb Chevrolet Vancouver, WA 360-450-0021 ★ 4.5 / 5.0 320 Verified Reviews ♥ 13 Customer Favorites		Vehicle serviced - Maintenance inspection completed - Oil and filter changed
08/14/2020		Utah Inspection Station		Passed emissions inspection
08/14/2020		Utah Motor Vehicle Dept. Syracuse, UT		Vehicle purchase reported - Title issued or updated - Registration issued or renewed - Loan or lien reported - Passed safety inspection - Registration updated when owner moved the vehicle to a new location - Vehicle color noted as Black
09/05/2020	85,392	Young Buick GMC Layton, UT 801-544-3445		Vehicle serviced - Maintenance inspection completed - Oil and filter changed

★ 4.5 / 5.0 151 Verified Reviews
♥ 80 Customer Favorites

12/28/2020 92,513 Young Buick GMC
Layton, UT
801-544-3445
★ 4.5 / 5.0 151 Verified Reviews
♥ 80 Customer Favorites



Vehicle serviced
- Maintenance inspection completed
- Alignment checked
- Oil and filter changed

04/14/2021 99,611 Young Buick GMC
Layton, UT
801-544-3445
★ 4.5 / 5.0 151 Verified Reviews
♥ 80 Customer Favorites



Vehicle serviced
- Maintenance inspection completed
- Alignment checked
- Oil and filter changed

09/01/2021 Utah
Inspection Station

Passed emissions inspection

09/01/2021 Utah
Motor Vehicle Dept.
Syracuse, UT

Registration issued or renewed
- Loan or lien reported
- Passed safety inspection
- Vehicle color noted as Black

12/13/2021 114,191 Young Buick GMC
Layton, UT
801-544-3445
★ 4.5 / 5.0 151 Verified Reviews
♥ 80 Customer Favorites



Vehicle serviced
- Maintenance inspection completed
- Alignment checked
- Oil and filter changed
- Tires rotated

02/07/2022 Damage Report

Damage reported: minor damage

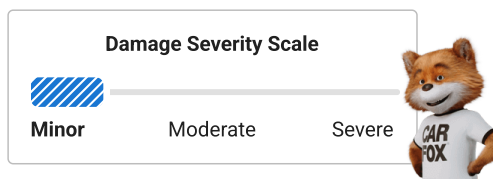

05/04/2022 120,845 Young Buick GMC
Layton, UT
801-544-3445
★ 4.5 / 5.0 151 Verified Reviews
♥ 80 Customer Favorites



Vehicle serviced
- Maintenance inspection completed
- Alignment checked
- Oil and filter changed

07/12/2022 122,872 Young Buick GMC
Layton, UT
801-544-3445
★ 4.5 / 5.0 151 Verified Reviews
♥ 80 Customer Favorites



Vehicle serviced
- Maintenance inspection completed
- Alignment performed
- Power steering checked

08/20/2022 Utah
Inspection Station

Passed emissions inspection

08/20/2022 Utah
Motor Vehicle Dept.
Clearfield, UT

Registration issued or renewed
- Loan or lien reported
- Passed safety inspection
- Registration updated when owner moved the vehicle to a new location
- Vehicle color noted as Black

08/31/2022 124,221 Young Buick GMC
Layton, UT
801-544-3445
★ 4.5 / 5.0 151 Verified Reviews
♥ 80 Customer Favorites



Vehicle serviced
- Pre-delivery inspection completed
- Alignment checked
- Antifreeze/coolant flushed/changed
- Brakes checked
- Engine timing/front cover gasket replaced
- Fluids checked
- Intake manifold gasket(s) replaced
- Oil and filter changed
- Safety inspection performed

- Tire(s) balanced
- Tires rotated
- Vehicle washed/detailed

09/07/2022

Young Chevrolet
Layton, UT
801-544-1234



Vehicle serviced
- Vehicle washed/detailed

★ **4.5 / 5.0** 233 Verified Reviews
♥ **205** Customer Favorites

















Owner 4
Purchased: 2022





Low mileage! This owner drove less than the industry average of 15,000 miles per year.

Personal Vehicle
12,932 mi/yr

Date	Mileage	Source	Comments
09/09/2022	124,240	Utah Motor Vehicle Dept.	Vehicle purchase reported
09/24/2022	124,754	Young Buick GMC Layton, UT 801-544-3445 ★ 4.5 / 5.0 151 Verified Reviews ♥ 80 Customer Favorites	Vehicle serviced - Battery charged
10/04/2022		Utah Inspection Station	Passed emissions inspection
10/04/2022		Utah Motor Vehicle Dept. Ogden, UT	Registration issued or renewed - New owner reported - Loan or lien reported - Passed safety inspection - Vehicle color noted as Black
10/28/2022	127,216	Young Chevrolet Layton, UT 801-544-1234 ★ 4.5 / 5.0 233 Verified Reviews ♥ 205 Customer Favorites	Vehicle serviced
10/28/2022	127,217	Young Buick GMC Layton, UT 801-544-3445 ★ 4.5 / 5.0 151 Verified Reviews ♥ 80 Customer Favorites	Vehicle serviced - Maintenance inspection completed - Alignment checked
10/31/2022		Utah Inspection Station	Passed emissions inspection
10/31/2022		Utah Motor Vehicle Dept. Ogden, UT Title #E001105499UT	Title issued or updated - Loan or lien reported - Vehicle color noted as Black
11/10/2022		Precision Auto Glass Layton, UT 801-425-4828 ★ 4.9 / 5.0 188 Verified Reviews	Vehicle serviced - Glass repaired
02/10/2023		Jiffy Lube Service Center #3423 Riverdale, UT 801-690-7682 ★ 4.5 / 5.0 57 Verified Reviews ♥ 28 Customer Favorites	Vehicle serviced
05/13/2023	132,428	Midas Roy, UT 801-773-6400 ★ 4.7 / 5.0 55 Verified Reviews	Vehicle serviced - Maintenance inspection completed - Brakes checked - Brake fluid flushed/changed

		 23 Customer Favorites		<ul style="list-style-type: none"> - Front brake pads replaced - Front brake rotor(s) replaced - Oil and filter changed - Rear brake pads replaced - Rear brake rotor(s) replaced - Wheel lug nuts torqued
06/07/2023	133,032	Young Buick GMC Layton, UT 801-544-3445  4.5 / 5.0 151 Verified Reviews  80 Customer Favorites		Vehicle serviced <ul style="list-style-type: none"> - Oil and filter changed - Tires rotated
10/26/2023	139,723	Young Buick GMC Layton, UT 801-544-3445  4.5 / 5.0 151 Verified Reviews  80 Customer Favorites		Vehicle serviced <ul style="list-style-type: none"> - Alignment checked - Oil and filter changed
02/17/2024	144,307	Young Subaru Ogden, UT 801-621-3431  4.7 / 5.0 913 Verified Reviews  558 Customer Favorites		Vehicle serviced <ul style="list-style-type: none"> - Inspection performed - Alignment checked - Emissions inspection performed
02/17/2024		Utah Inspection Station		Passed emissions inspection View the complete inspection report
02/17/2024		Utah Motor Vehicle Dept. Ogden, UT Title #E001105499UT		Registration issued or renewed <ul style="list-style-type: none"> - Passed safety inspection - Vehicle color noted as Black
05/20/2024	148,313	Young Buick GMC Layton, UT 801-544-3445  4.5 / 5.0 151 Verified Reviews  80 Customer Favorites		Vehicle serviced <ul style="list-style-type: none"> - Maintenance inspection completed - Oil and filter changed
05/21/2024		Midas Roy, UT 801-773-6400  4.7 / 5.0 55 Verified Reviews  23 Customer Favorites		Vehicle serviced <ul style="list-style-type: none"> - Maintenance inspection completed - Brakes checked - Brake caliper(s) replaced - Brake fluid flushed/changed - Brake rotor(s) replaced - Oil and filter changed - Rear brake caliper(s) replaced - Rear brake pads replaced - Rear brake rotor(s) replaced - Wheel lug nuts torqued
05/21/2024	148,338	Young Subaru Ogden, UT 801-621-3431  4.7 / 5.0 913 Verified Reviews  558 Customer Favorites		Vehicle serviced <ul style="list-style-type: none"> - Four wheel alignment performed
01/10/2025		Jiffy Lube Roy, UT 801-648-7490  4.2 / 5.0 72 Verified Reviews  26 Customer Favorites		Vehicle serviced <ul style="list-style-type: none"> - Antifreeze/coolant checked - Antifreeze/coolant flushed/changed - Emission system checked - Safety inspection performed
01/24/2025		Utah Inspection Station		Passed emissions inspection
01/24/2025		Utah Motor Vehicle Dept. Ogden, UT Title #E001105499UT		Registration issued or renewed <ul style="list-style-type: none"> - Passed safety inspection - Vehicle color noted as Black

06/25/2025	163,286	Take 5 Oil Change Riverdale, UT 385-206-8368 ★ 4.8 / 5.0 83 Verified Reviews ♥ 2 Customer Favorites		Vehicle serviced - Oil and filter changed
07/02/2025		Utah Inspection Station		Passed emissions inspection
07/02/2025		Utah Motor Vehicle Dept. Ogden, UT Title #E001105499UT		Registration issued or renewed - Passed safety inspection - Vehicle color noted as Black
09/26/2025	165,864	Ken Garff Buick GMC Riverdale Ogden, UT 801-627-6700 ★ 4.5 / 5.0 165 Verified Reviews ♥ 109 Customer Favorites		Vehicle serviced - Maintenance inspection completed - Alignment checked - Alignment performed - Body electrical system checked - Engine checked - Four wheel alignment performed - Steering/suspension checked - Tie rod(s) replaced - Turn signal bulb(s) replaced
02/05/2026	168,352	Jiffy Lube Ogden, UT 801-689-2870 ★ 4.5 / 5.0 116 Verified Reviews ♥ 35 Customer Favorites		Vehicle serviced - Emission system checked - Safety inspection performed
02/05/2026		Utah Inspection Station		Passed emissions inspection
02/05/2026		Utah Motor Vehicle Dept. Ogden, UT Title #E001105499UT		Registration issued or renewed - Passed safety inspection - Registration updated when owner moved the vehicle to a new location - Vehicle color noted as Black
03/20/2026		Utah Inspection Station		Passed emissions inspection
03/20/2026		Utah Motor Vehicle Dept. Ogden, UT Title #UT012503554		Title issued or updated - Duplicate title issued - Vehicle color noted as Black

Have Questions? Consumers, please visit our Help Center at www.carfax.com. Dealers or Subscribers, please visit our Help Center at www.carfaxonline.com.

Glossary

Accident Indicator

CARFAX receives information about accidents in all 50 states, the District of Columbia and Canada.

Not every accident is reported to CARFAX. As details about the accident become available, those additional details are added to the CARFAX Vehicle History Report. CARFAX recommends that you have this vehicle inspected by a qualified mechanic.

- According to the National Safety Council, Injury Facts, 2021 edition, 5% of the 276 million registered vehicles in the U.S. were involved in an accident in 2019. Over 77% of these were considered minor or moderate.
- This CARFAX Vehicle History Report is based only on information supplied to CARFAX and available as of 4/8/26 at 5:52:29 PM (CDT). Other information about this vehicle, including problems, may not have been reported to CARFAX. Use this report as one important tool, along with a vehicle inspection and test drive, to make a better decision about your next used car.

Damage Indicator

Damage can be a result of many different types of events. Examples include contact with objects (other cars, trees, traffic signs, road debris, etc), vandalism, or weather-related events. Not every damage event is reported to CARFAX. As details about the damage event become available, those additional details are added to the CARFAX Vehicle History Report. CARFAX recommends that you have this vehicle inspected by a qualified mechanic.

- This CARFAX Vehicle History Report is based only on information supplied to CARFAX and available as of 4/8/26 at 5:52:29 PM (CDT). Other information about this vehicle, including problems, may not have been reported to CARFAX. Use this report as one important tool, along with a vehicle inspection and test drive, to make a better decision about your next used car.

Damage Severity

Damage events result in one of the following severity levels:

- Minor: Generally, minor damage is cosmetic (including dents or scratches), may only require reconditioning, and typically does not compromise a vehicle's operation and/or safety.
- Moderate: Moderate damage may affect multiple components of the vehicle and may impair the vehicle's operation and/or safety.
- Severe: Severe damage usually affects multiple components of the vehicle and is likely to compromise the vehicle's operation and/or safety.

CARFAX recommends getting a pre-purchase inspection at a certified collision repair facility.

First Owner

When the first owner(s) obtains a title from a Department of Motor Vehicles as proof of ownership.

New Owner Reported

When a vehicle is sold to a new owner, the Title must be transferred to the new owner(s) at a Department of Motor Vehicles.

Ownership History



CARFAX defines an owner as an individual or business that possesses and uses a vehicle. Not all title transactions represent changes in ownership. To provide estimated number of owners, CARFAX proprietary technology analyzes all the events in a vehicle history. Estimated ownership is available for vehicles manufactured after 1991 and titled solely in the US including Puerto Rico. Dealers sometimes opt to take ownership of a vehicle and are required to in the following states: Maine, Massachusetts, New Jersey, Ohio, Oklahoma, Pennsylvania and South Dakota. Please consider this as you review a vehicle's estimated ownership history.

Reliability Forecast

The CARFAX 3-Year Reliability Forecast predicts the likelihood of repairs for a vehicle over the next three years. This forecast is based on vehicles of the same year, make, and model with similar mileage, damage, service history, and other factors, and assumes an average of 15,000 miles driven per year. Repairs are separate from regular maintenance, such as oil changes. Some of the repairs predicted may be covered under warranty. The 3-Year Reliability Forecast is based on data reported to Carfax and is only a prediction, not a guarantee.

Title Issued

A state issues a title to provide a vehicle owner with proof of ownership. Each title has a unique number. Each title or registration record on a CARFAX report does not necessarily indicate a change in ownership. In Canada, a registration and bill of sale are used as proof of ownership.

Follow Us:  facebook.com/CARFAX  [@CARFAXinc](https://twitter.com/CARFAXinc)  [About CARFAX](#)

CARFAX DEPENDS ON ITS SOURCES FOR THE ACCURACY AND RELIABILITY OF ITS INFORMATION. THEREFORE, NO RESPONSIBILITY IS ASSUMED BY CARFAX OR ITS AGENTS FOR ERRORS OR OMISSIONS IN THIS REPORT. CARFAX FURTHER EXPRESSLY DISCLAIMS ALL WARRANTIES, EXPRESS OR IMPLIED, INCLUDING ANY IMPLIED WARRANTIES OF MERCHANTABILITY OR FITNESS FOR A PARTICULAR PURPOSE.

© 2026 CARFAX, Inc., part of S&P Global. All rights reserved.

4/8/26 5:52:29 PM (CDT)